



## ROBOTİK ENDÜSTRİYEL ÇÖZÜMLER

Mühendislik Hizmetleri  
Konveyör İmalat ve Tasarım  
Makina İmalat Endüstrisi,  
Çelik İmalat Endüstrisi  
Fikstür İmalat ve Tasarım  
Otomotiv Endüstrisi  
Endüstriyel Otomasyon  
Beyaz Eşya Endüstrisi



we build  
the future

# ROBOTİK ENDÜSTRİYEL ÇÖZÜMLER

ANZ Robotics & Engineering, bilgi, deneyim ve yetenekli insan kaynakları gibi değerleriyle, gelişmiş teknolojiye sahip güçlü altyapısı sayesinde; prestijli, büyük ve önemli projelere imza atıp, sektöründe haklı bir takdir kazanmıştır.

ANZ Robotics & Engineering yurtiçi ve yurtdışında her türlü otomasyon ve mühendislik işlerinde profesyonel hizmet vermektedir. Firmamız kapasitesini ve üretimini sürekli katlayarak arttırmış ve önemli referans projeleri tamamlamıştır.

ANZ Robotics & Engineering, dinamizmi, çözümcü yaklaşımları ve teknik kabiliyetleri sayesinde daima "zamanın ötesinde uygulamalar" için çalışır.

Uluslararası standartlara uygun proje yönetim sistemiyle kapsam, maliyet ve zaman kısıtlarını kalite standartları içinde yöneterek; otomotiv, beyaz eşya, makina endüstrisi, çelik imalat endüstrisi gibi farklı sektörlerde başarılı projeler yürütüyoruz.



www.anz.com.tr

## 30 YILLIK DENEYİM

Uzun yıllar sektörün içinde olan ekibimiz ile tecrübelerimizden faydalanarak ve yeni teknolojileri yakından takip ederek her zaman kaliteli, yenilikçi, hızlı ve rekabetçi çözümler sunuyoruz.

“Profesyonel ve uzman ekibimiz ile müşterilerimize doğru çözümler sunarak geleceği inşa ediyoruz.”

Otomasyon teknolojimiz otomotiv ana ve yan sanayi, beyaz eşya, makine imalat, paketleme, yiyecek ve içecek, inşaat ve tekstil sektörleri başta olmak üzere farklı sektörlerde yer alan müşterilerin otomasyon ihtiyaçlarını dinlemek ve onların ihtiyaçlarına çözüm üretmek öncelikli hedefimizdir.



## SERVİS

Projelerin her aşamasında en iyi destek

**Ürün Geliştirme**  
En kısa geliştirme süreleri ve mümkün olan en iyi farklılık. 30 yılı aşkın pazar tecrübemizle derin bir branş bilgisine sahibiz.

**Devreye Alma ve Kabul**  
En hızlı devreye alma ve ürün değişimi ile yerinde uzmanlarla kapsamlı destek.

**Satış Sonrası Hizmet**  
Müşterilerimizin ürün seçiminde etkin olan önemli faktörlerinden biri de, firmamızın satış sonrasında sunmuş olduğu servis hizmetidir. Verilen servis hizmetinin kalitesi, sürekliliği, güvenilirliği ve yedek parça garantisi ile servis hizmetlerimiz ile müşteri memnuniyeti en üst seviyelerde tutulmaktadır.

- Mühendislik Hizmetleri
- Konveyör İmalat ve Tasarım
- Makina İmalat Endüstrisi
- Çelik İmalat Endüstrisi
- Fikstür İmalat ve Tasarım
- Otomotiv Endüstrisi
- Endüstriyel Otomasyon
- Beyaz Eşya Endüstrisi



İş Sağlığı ve Güvenliği Ofisi



Çalışma Ofisi

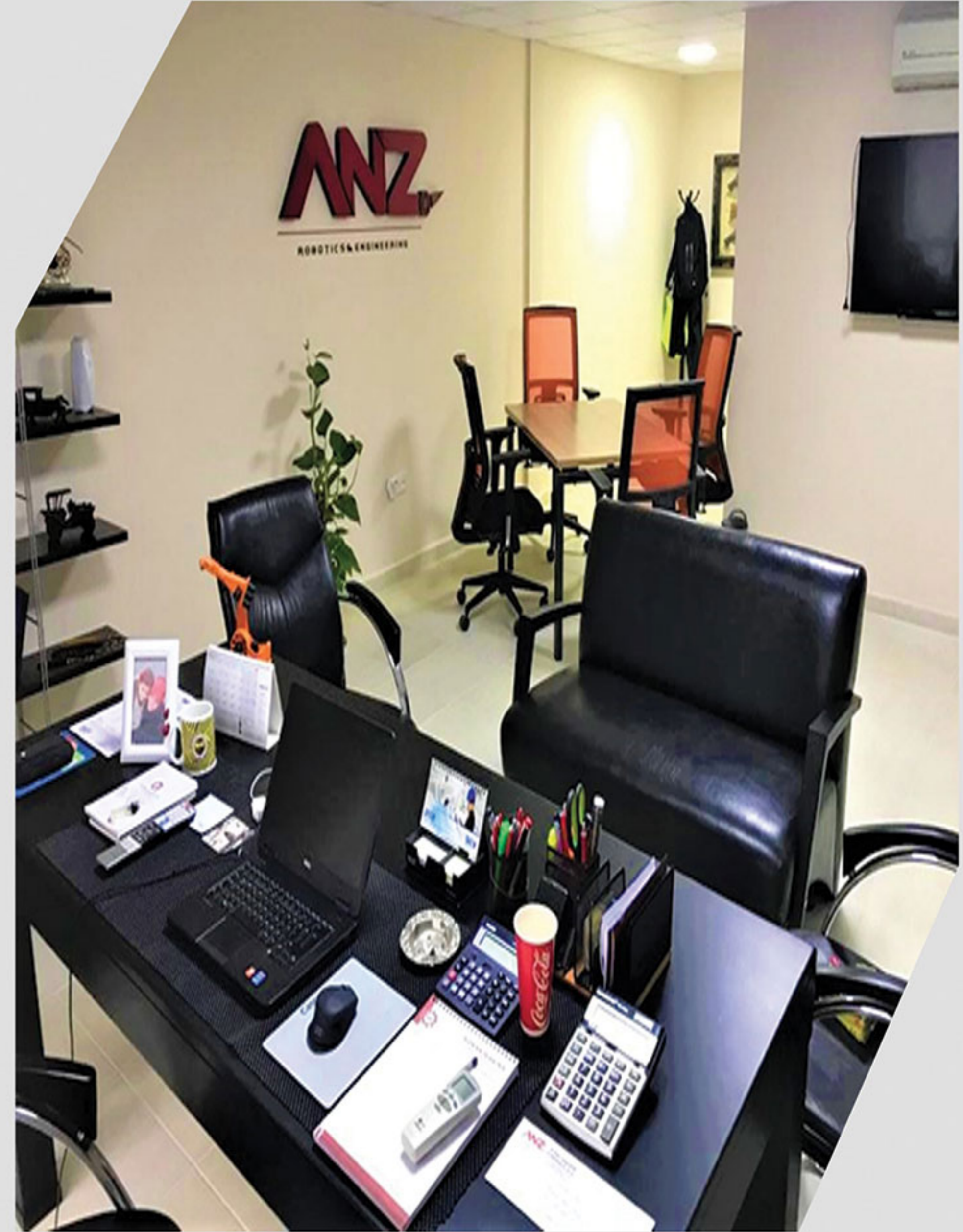

Mühendislik Ofisi





# İMİALATHANE





# İMİALATHANE

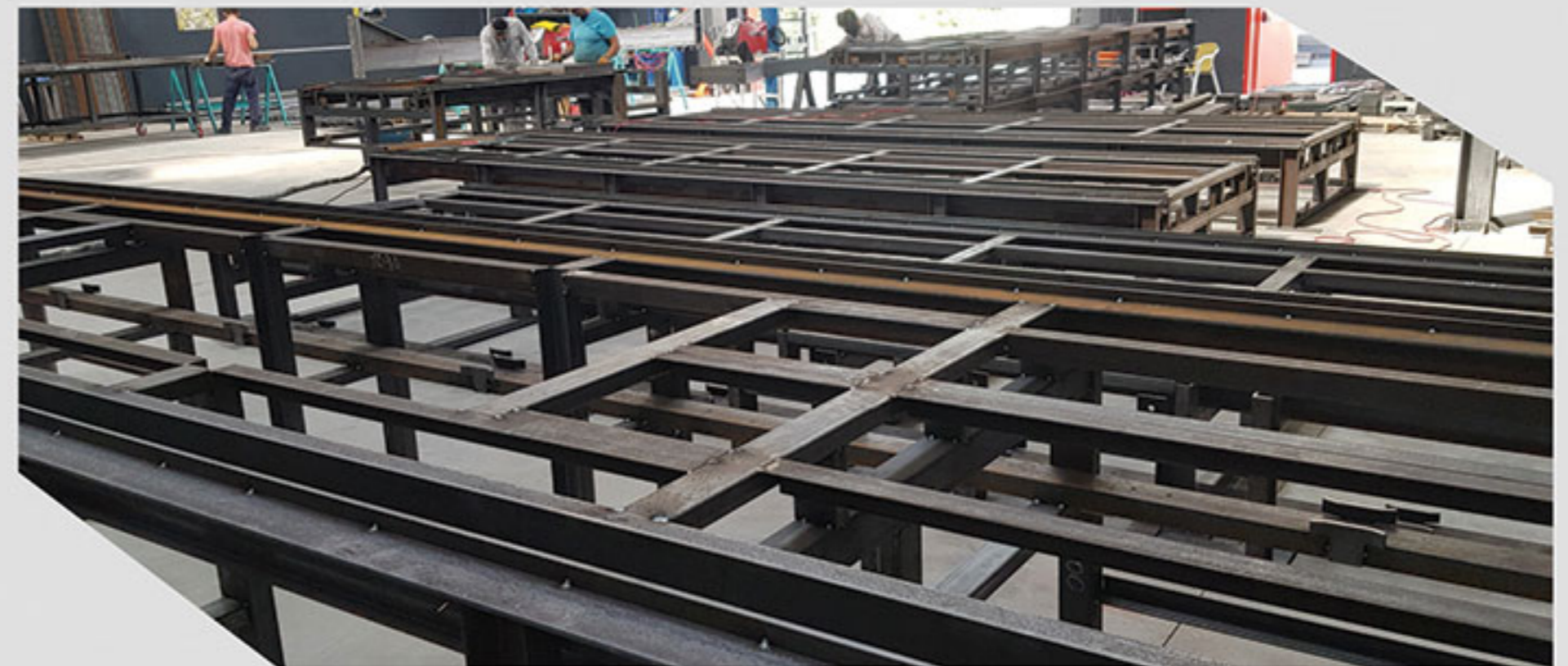



# ENDÜSTRİYEL ÇELİK İMALATI

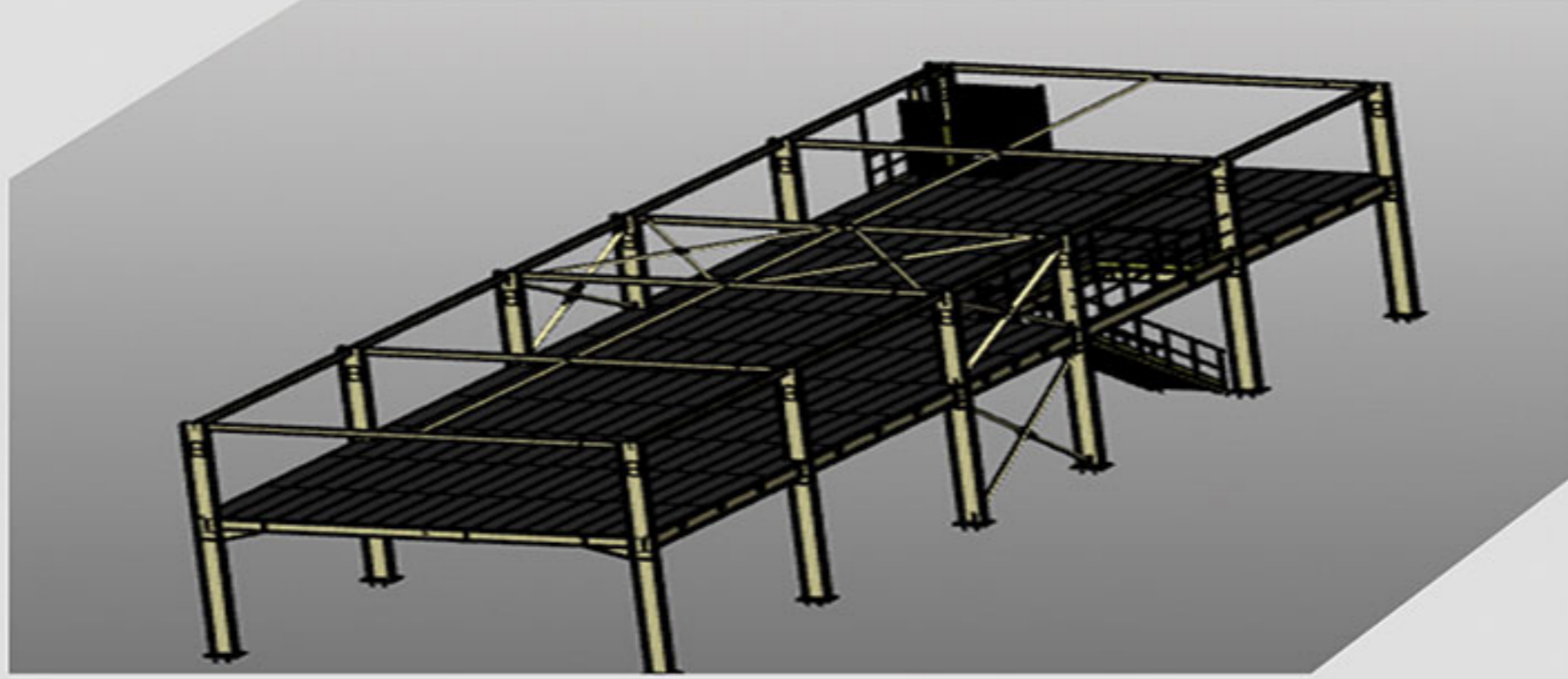



# ENDÜSTRİYEL ÇELİK İMALATI

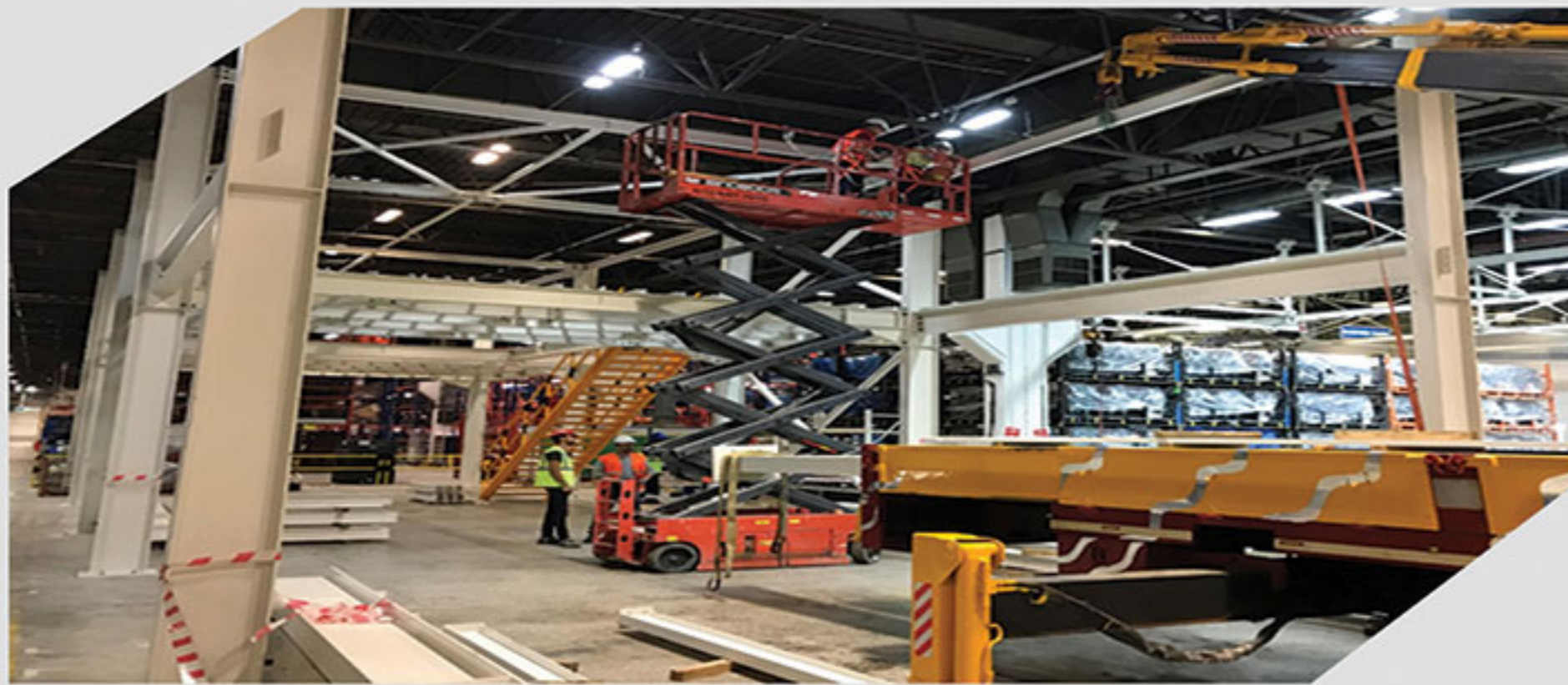
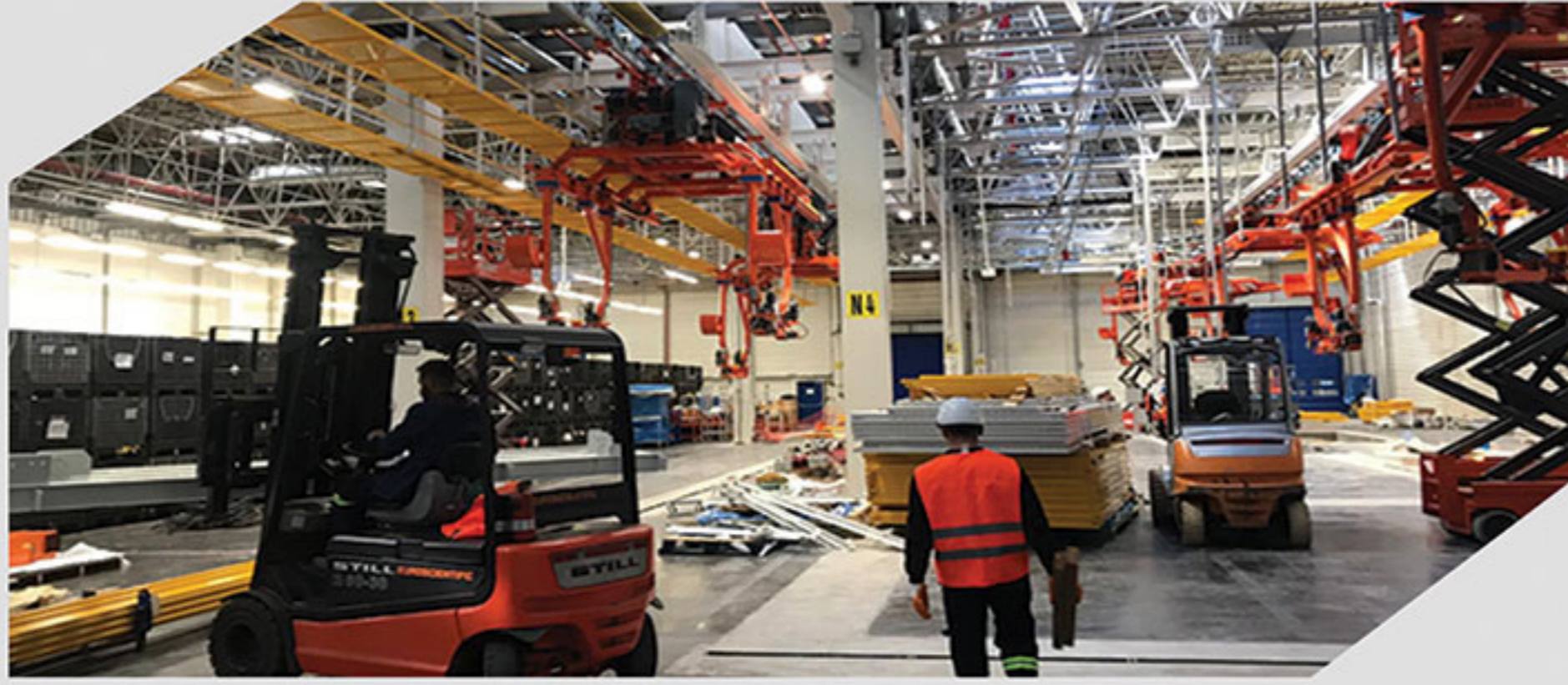



# ENDÜSTRİYEL ÇELİK İMALATI

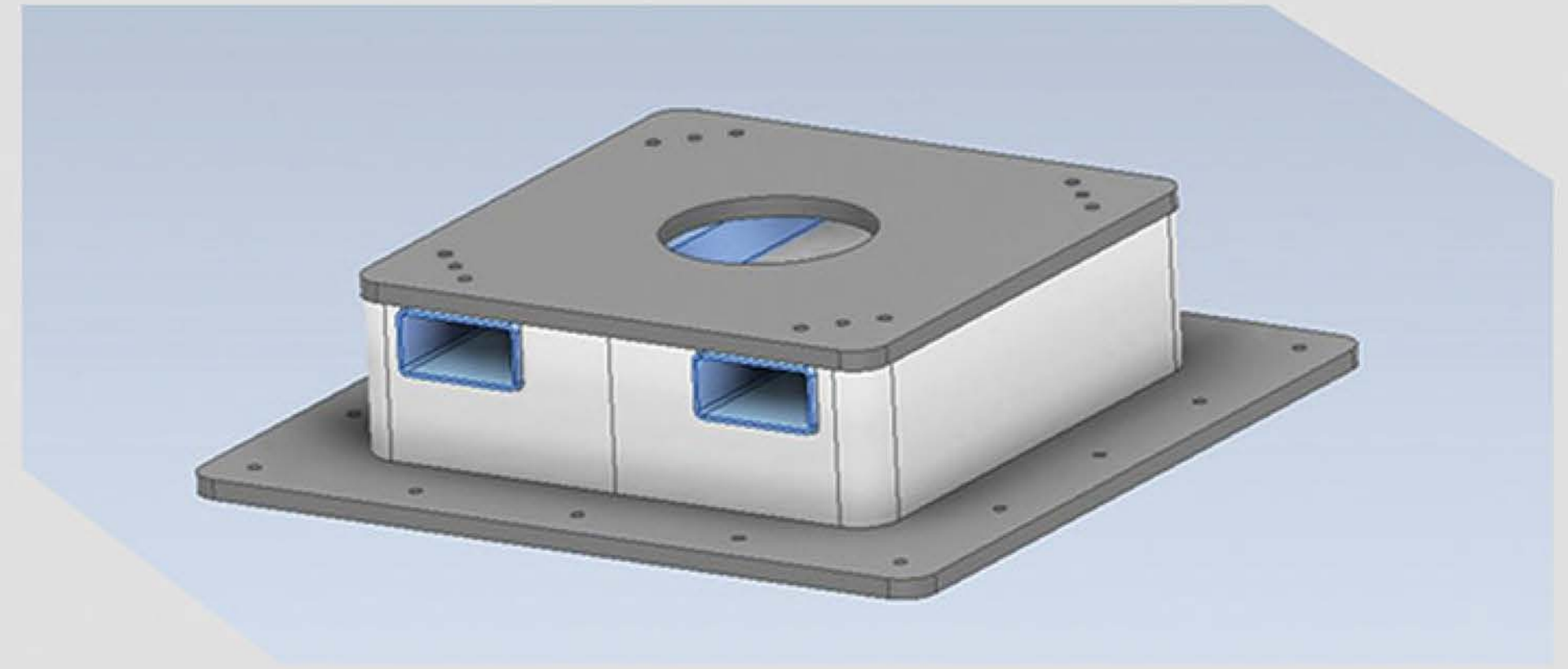
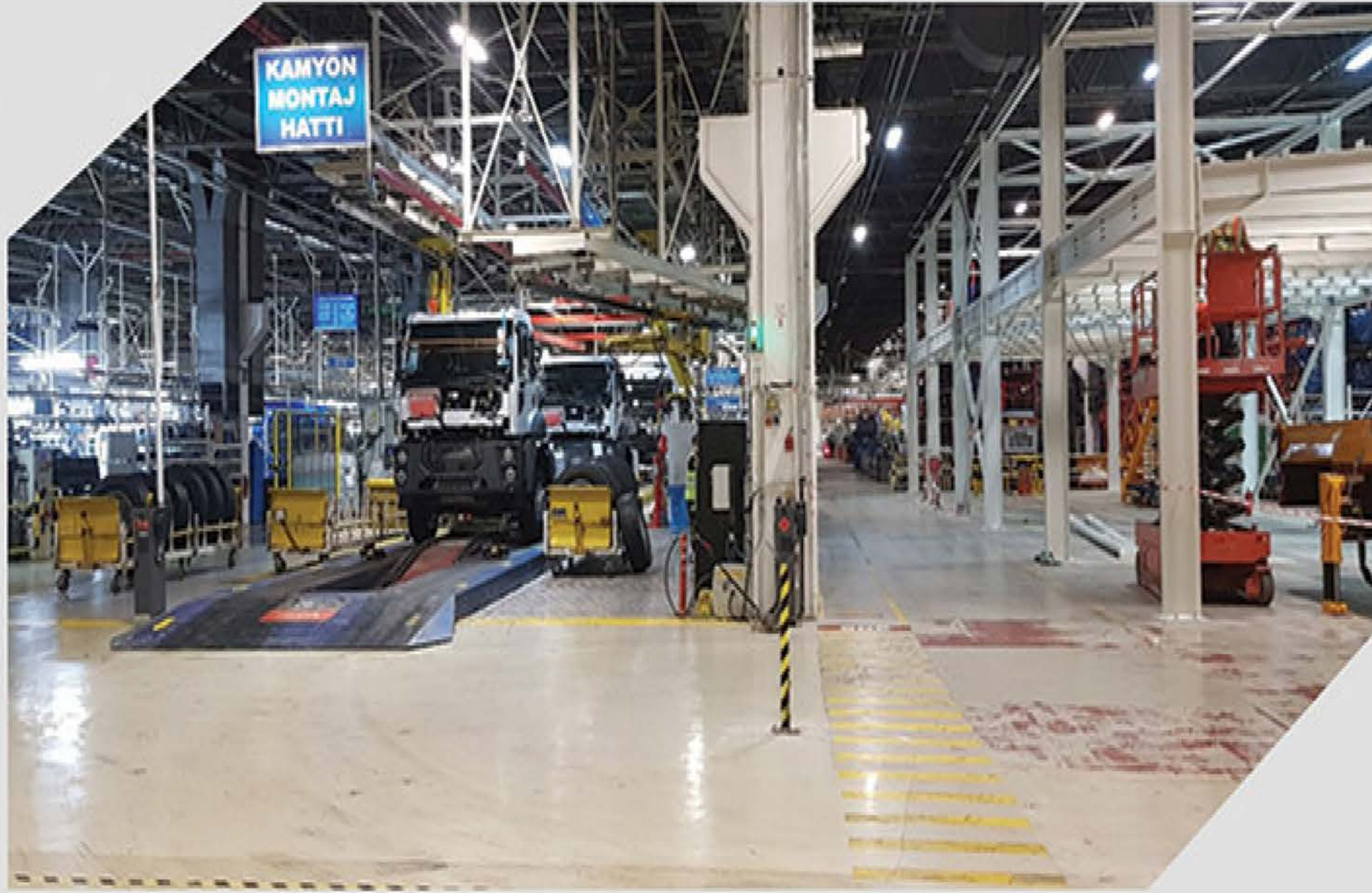



## ENDÜSTRİYEL ÇELİK İMALATI

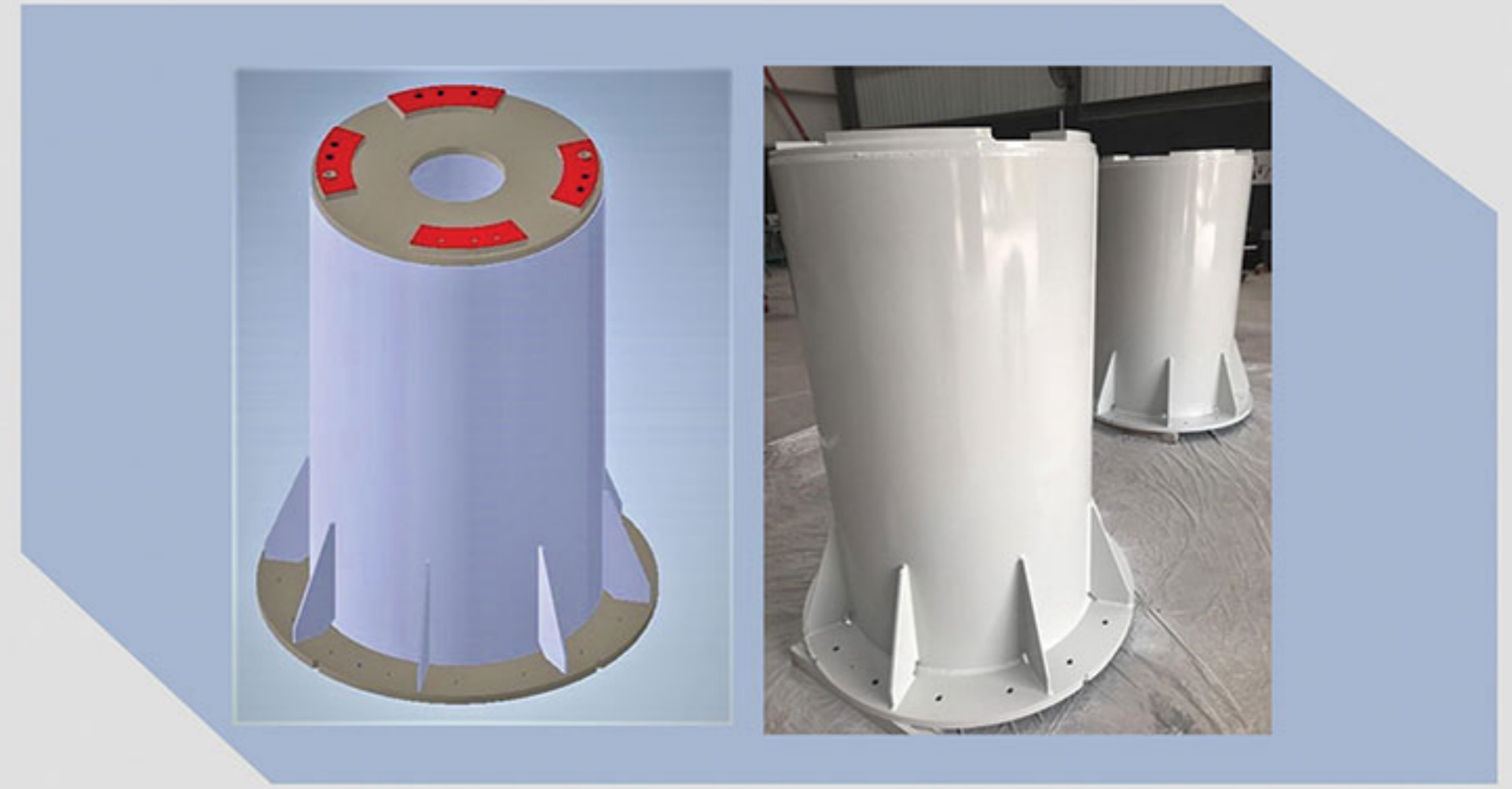
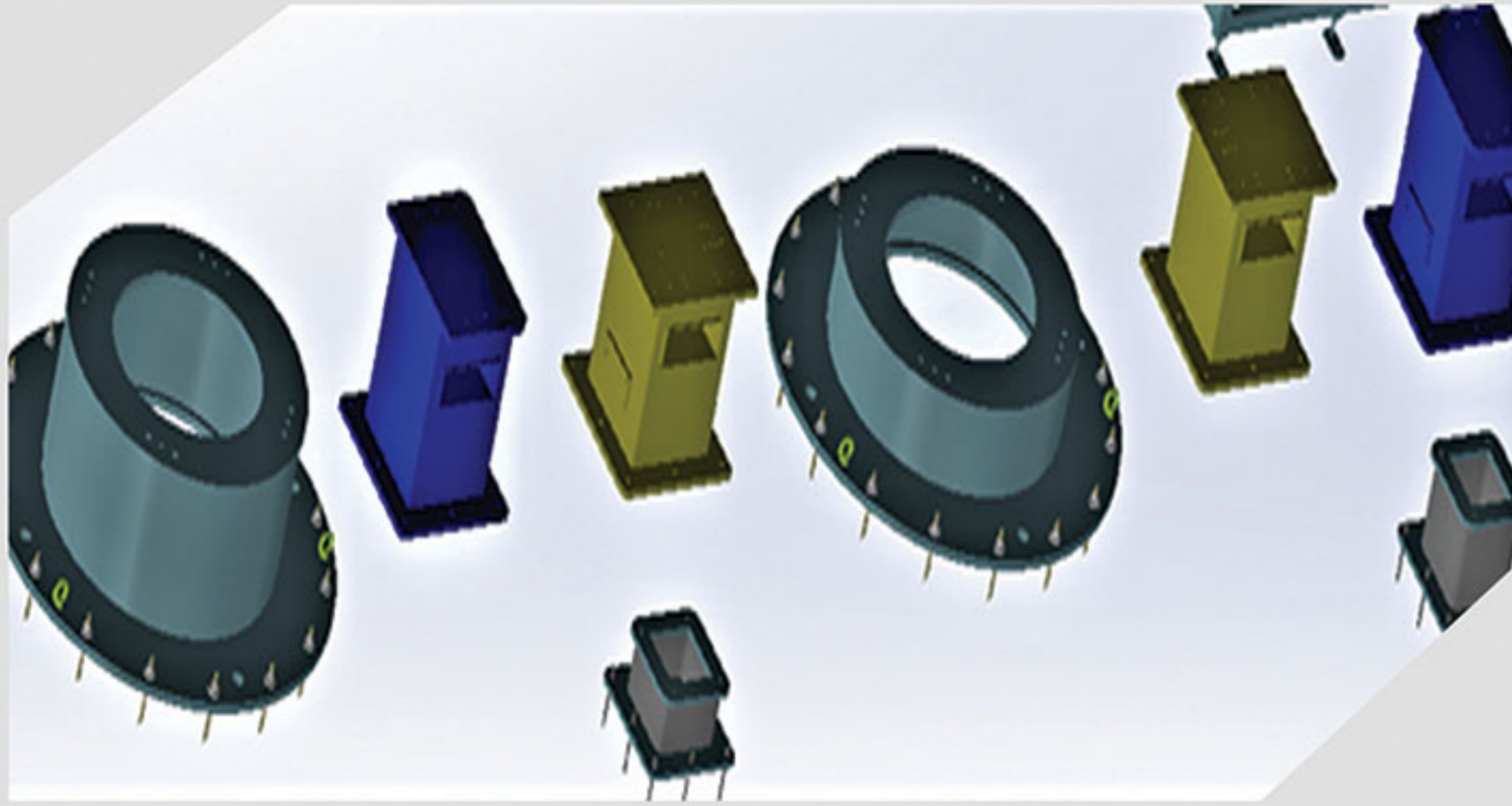



# KONVEYÖR İMALATI

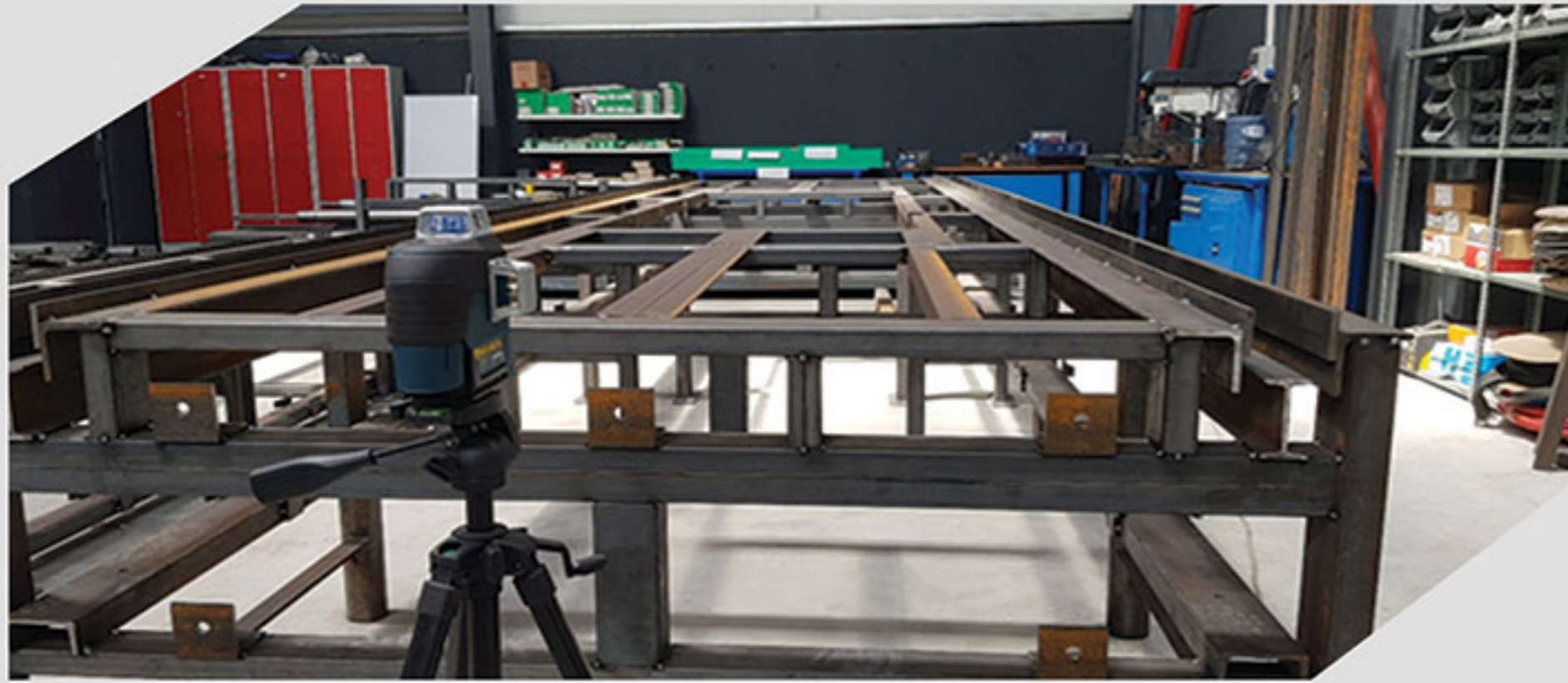



# KONVEYÖR İMALATI

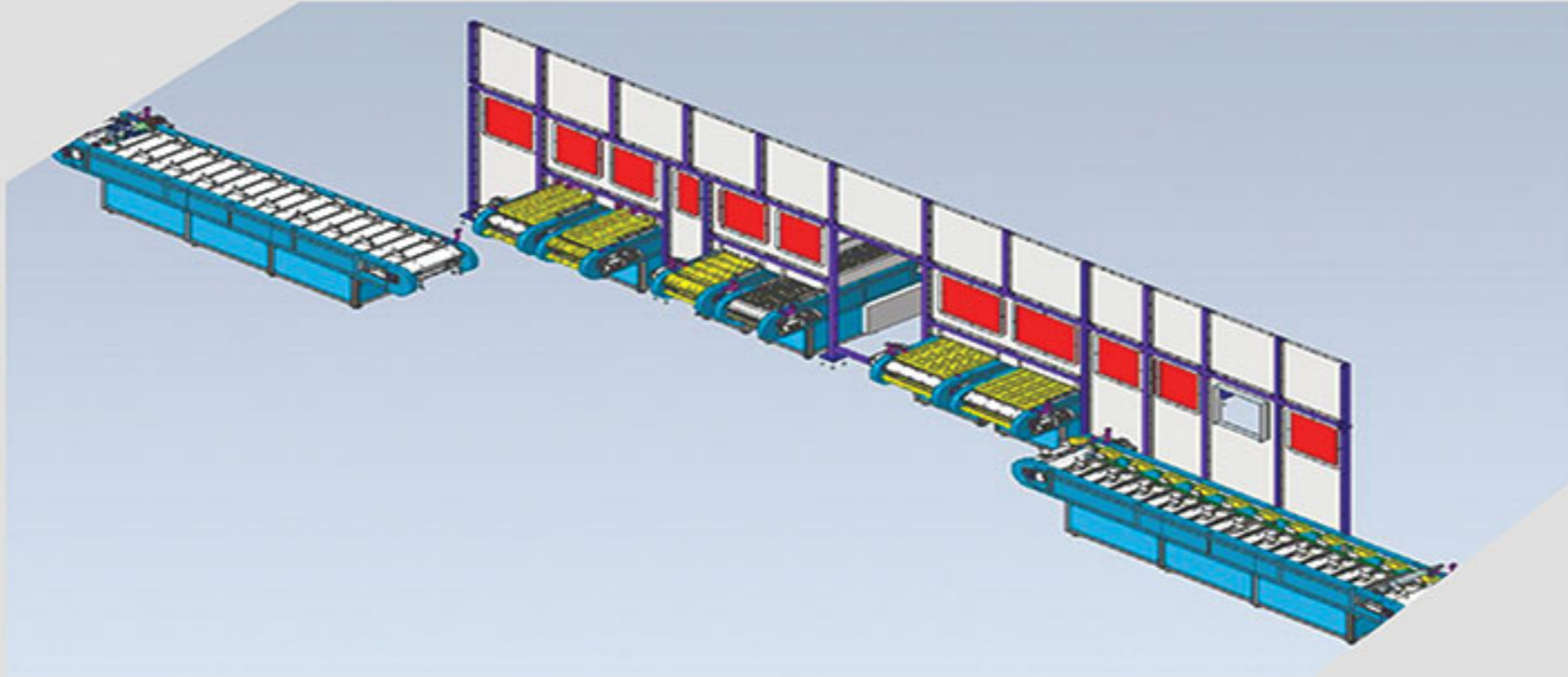



# KONVEYÖR İMALATI

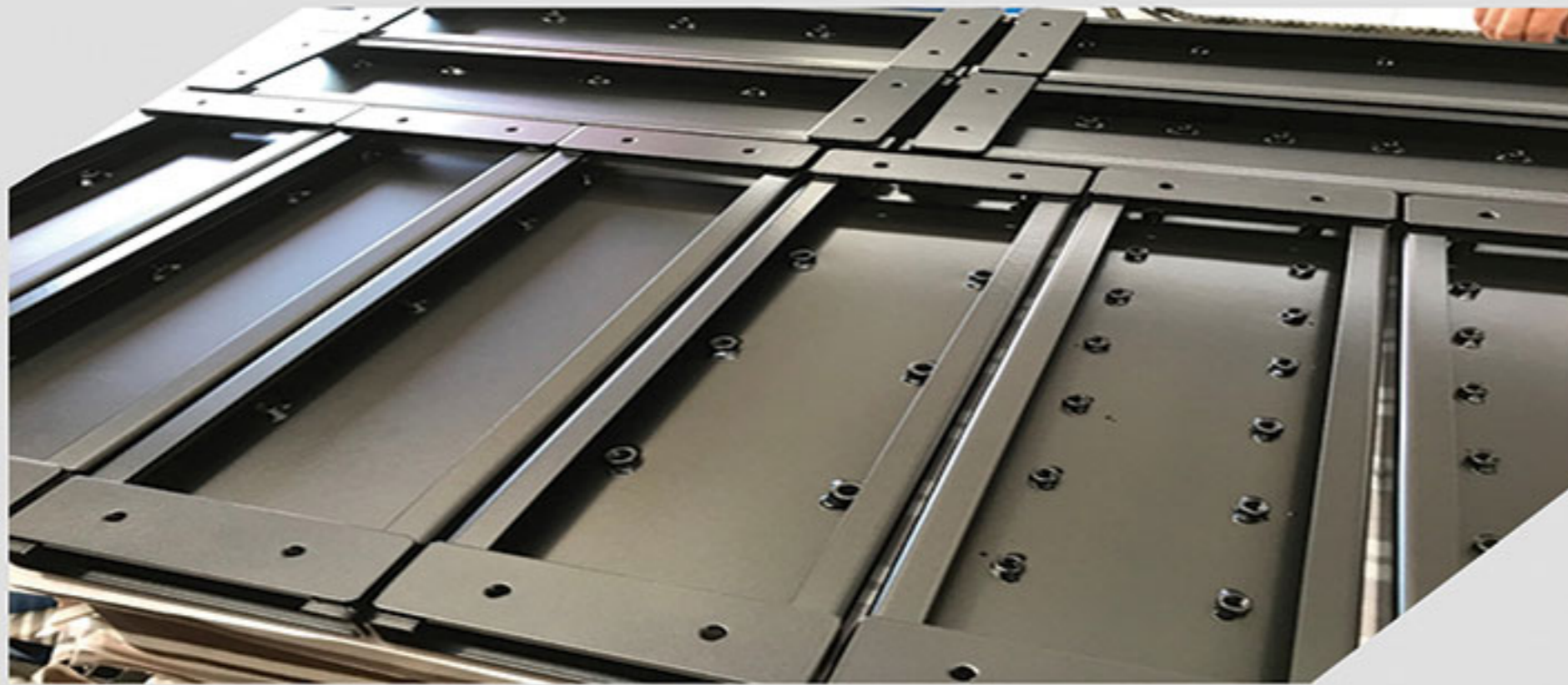
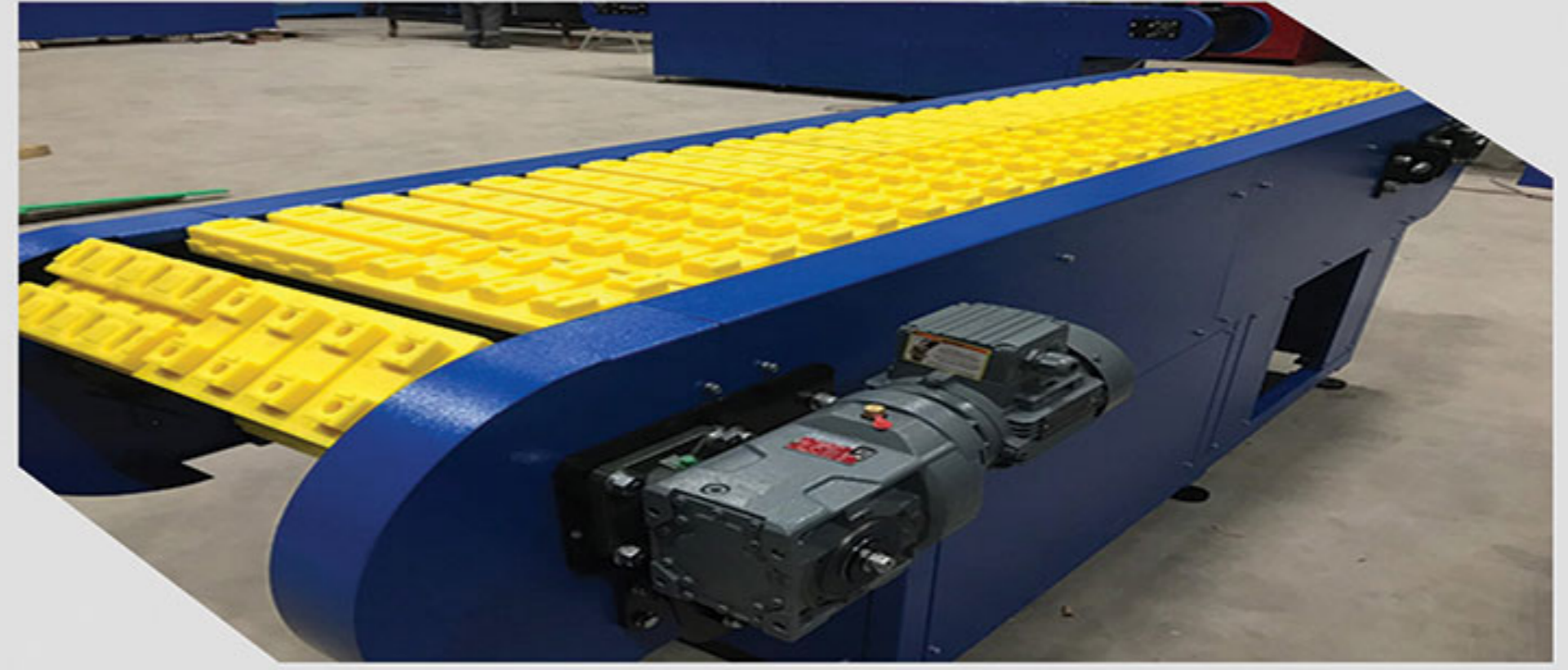
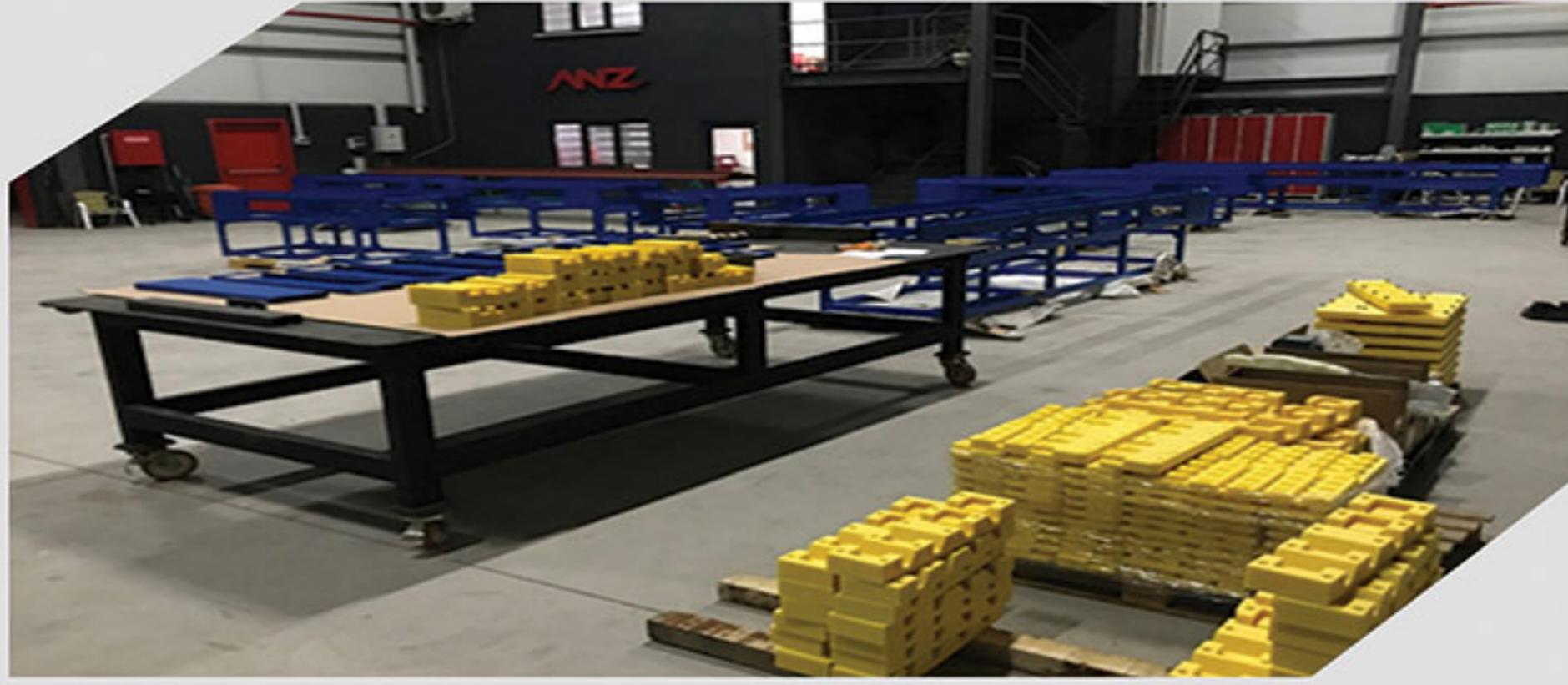



# KONVEYÖR İMALATI

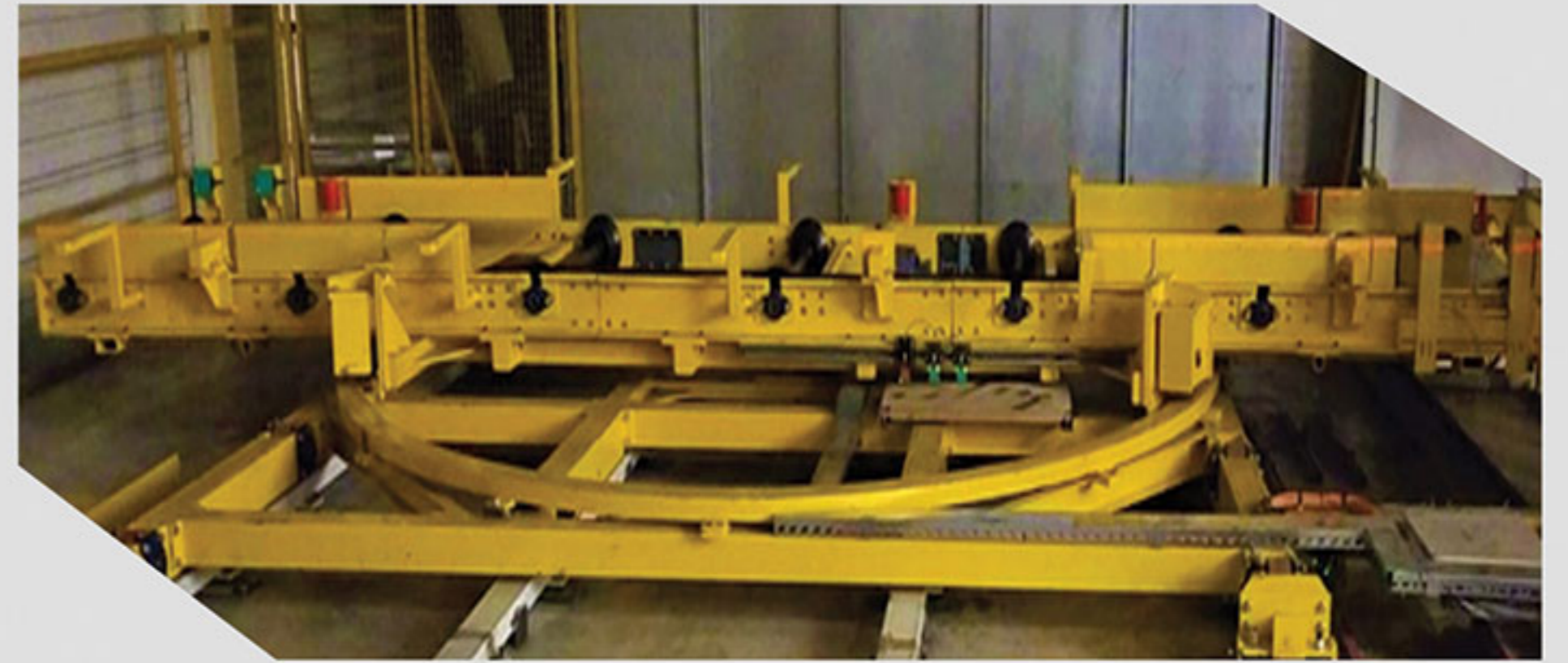
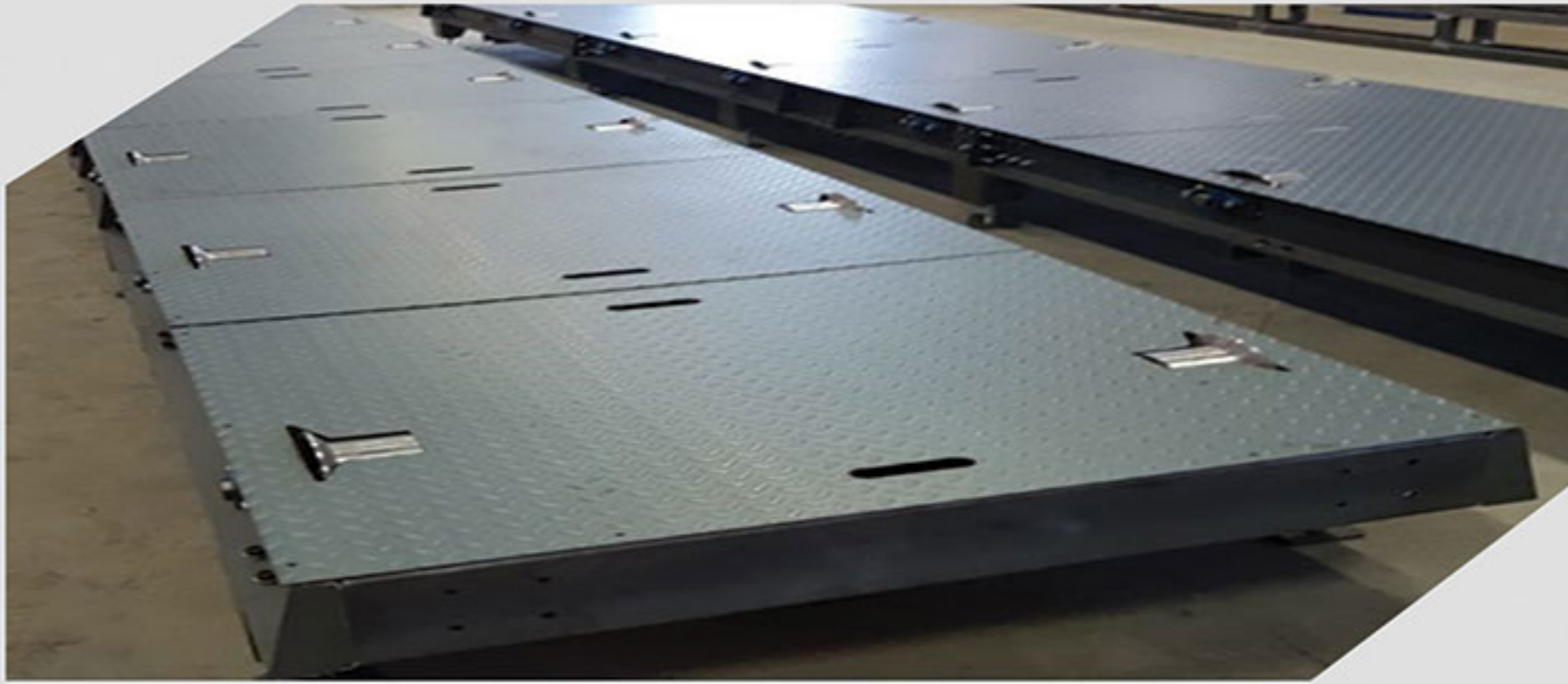
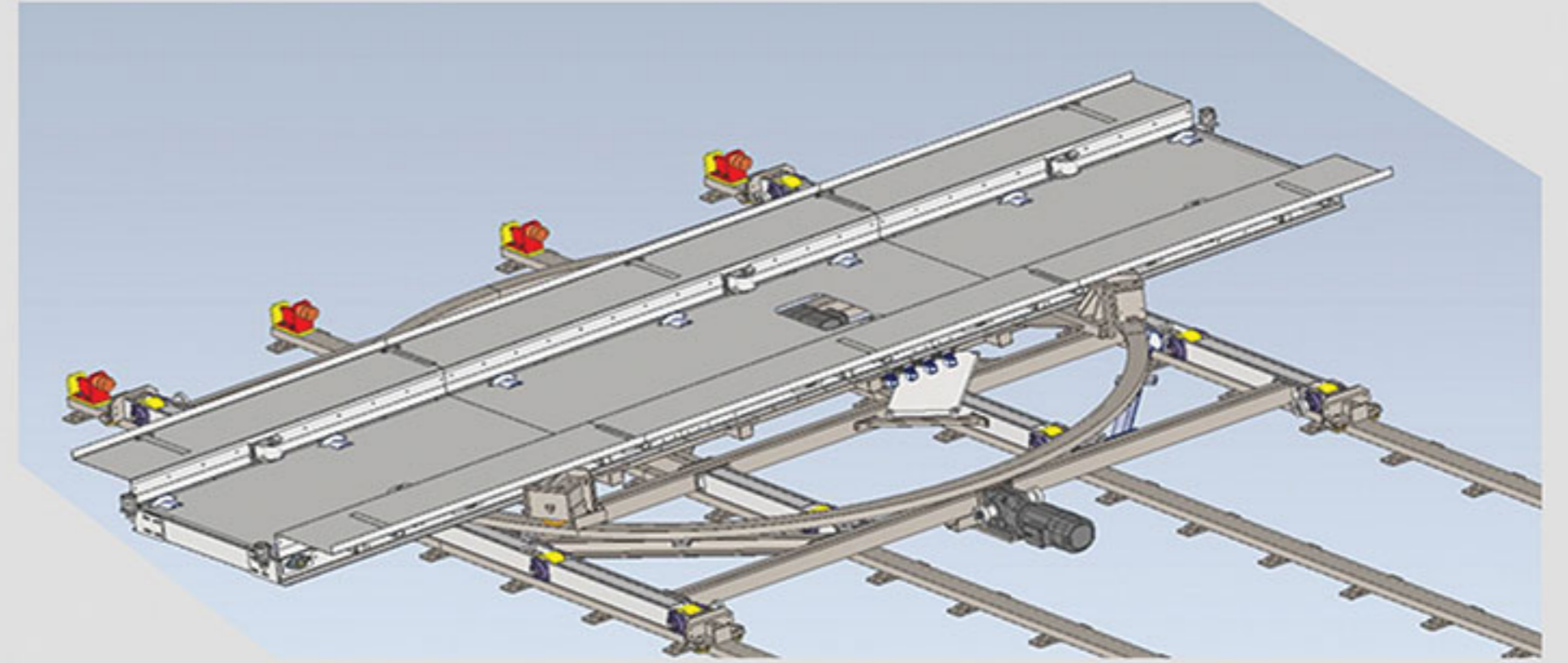



# OTOMOTİV ENDÜSTRİSİ

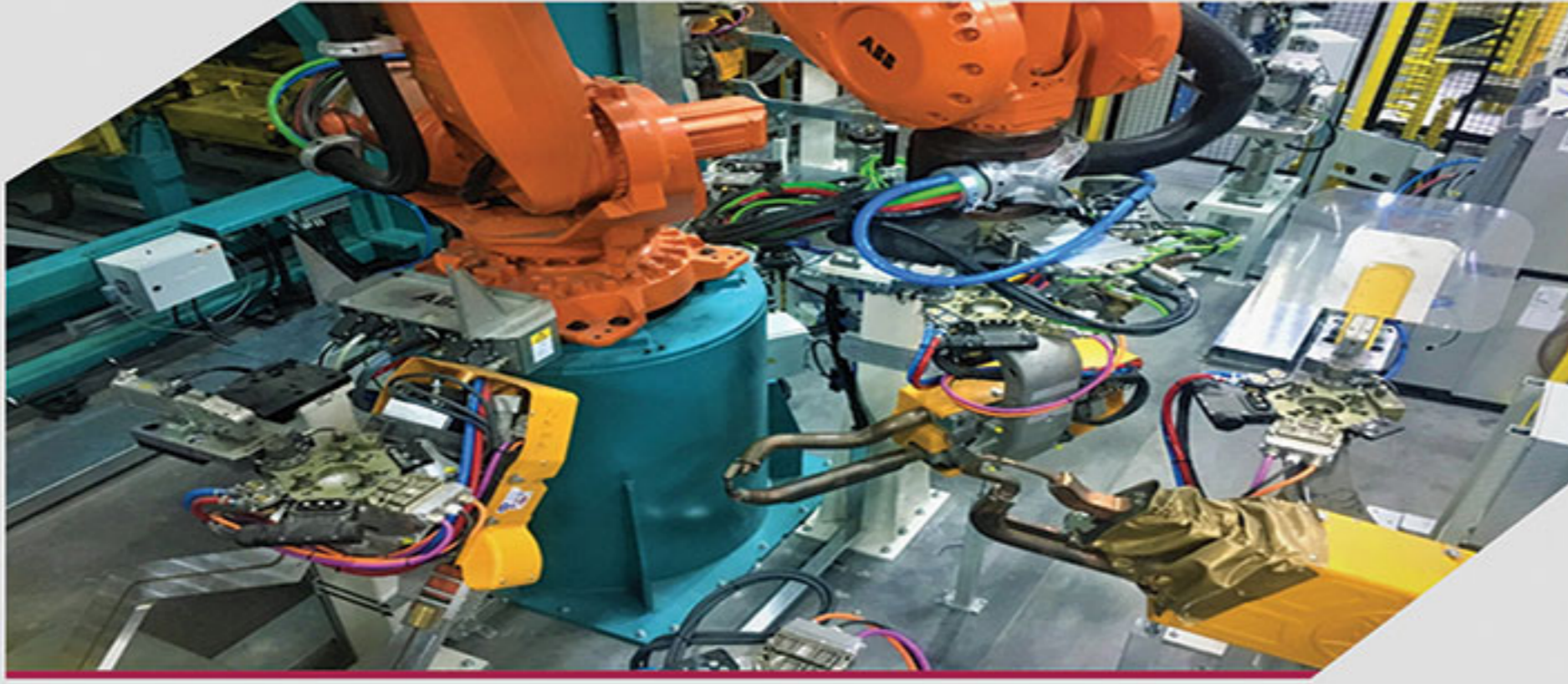



# MÜHENDİSLİK HİZMETLERİ

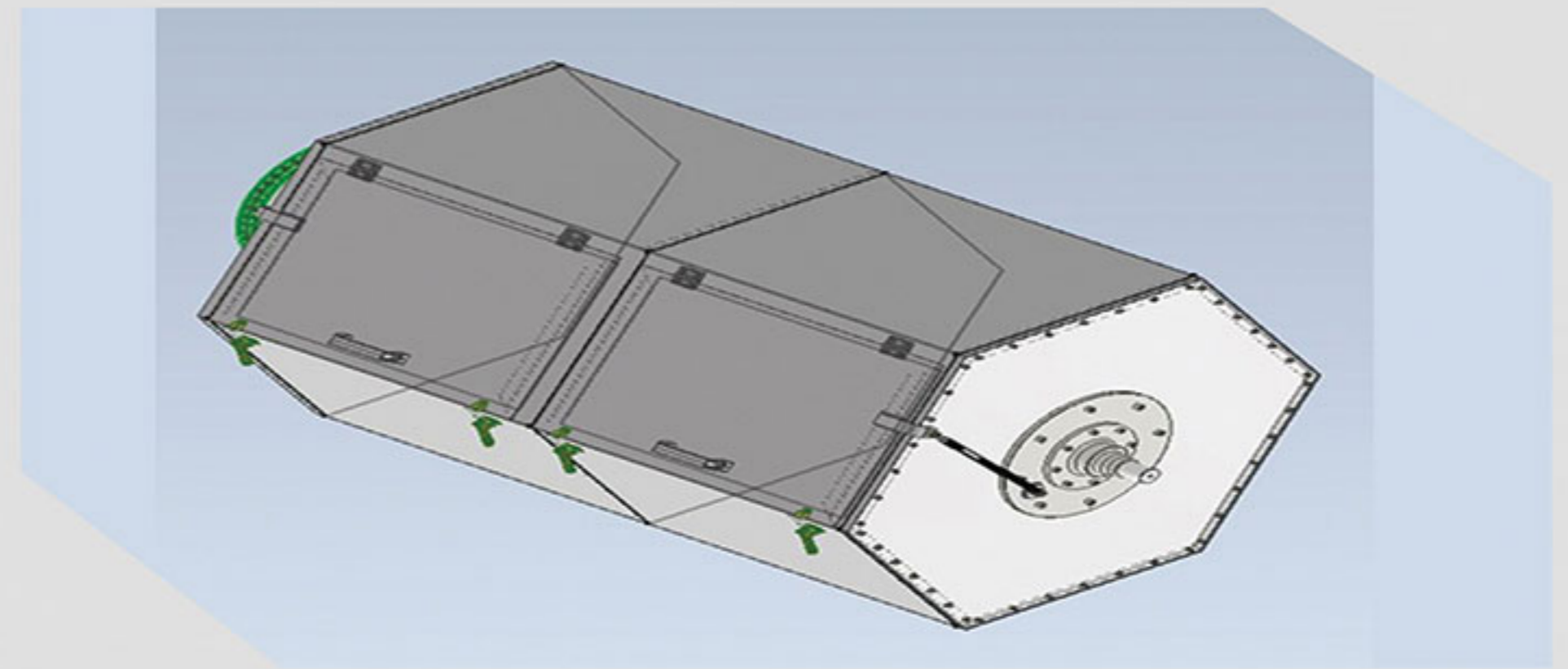
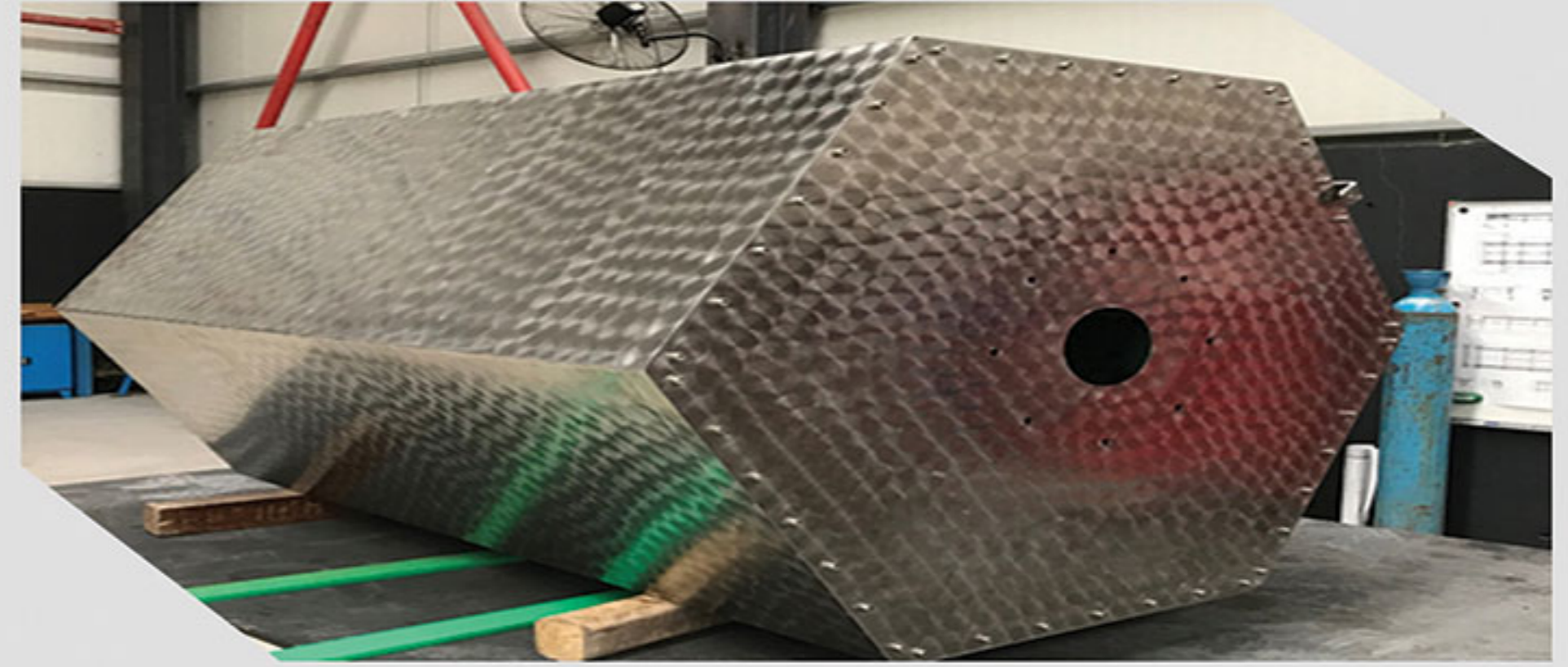
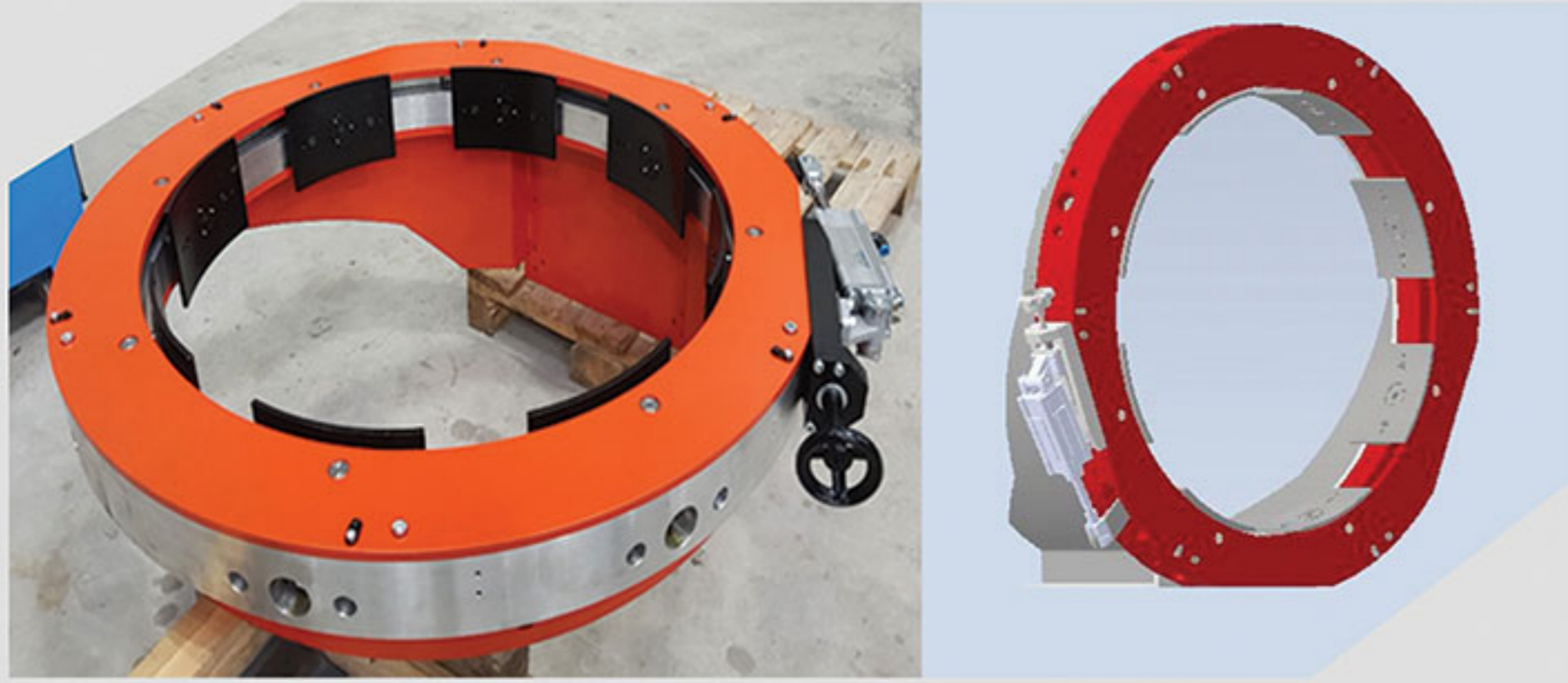



# ENDÜSTRİYEL OTOMASYON



## FİKSTÜR İMALATI







## ROBOTİK ENDÜSTRİYEL ÇÖZÜMLER

Mühendislik Hizmetleri  
Konveyör İmalat ve Tasarım  
Makina İmalat Endüstrisi,  
Çelik İmalat Endüstrisi  
Fikstür İmalat ve Tasarım  
Otomotiv Endüstrisi  
Endüstriyel Otomasyon  
Beyaz Eşya Endüstrisi